

ML50 Marine Lantern

	<p>Products description and application</p> <p>ML50 marine lantern can be issued at night lights, and meet the visible distance of five to seven nautical miles, used to nocturnal ship guidance. Applicable to the marine buoys, river buoys, shore, fixed lampposts and offshore oil derrick lights and so on. The unique design allows the ML50 marine lantern to be used in harsh environments.</p> <p>Features</p> <ul style="list-style-type: none"> ● Based on LED technology, its color meets IALA Recommendations E-200-1 requirements. ● PC housing, lamp body integration design, to IP68 protection level. ● PC material, anti-UV, anti-vibration, corrosion-resistant, with anti-bird device. ● 256 kinds of light quality adjustable, in line with IALA requirements. ● Adjustable light intensity, light control automatically adjustable switching illuminance threshold. ● Work stability, low maintenance costs. ● With RS-485 communication interface. ● Synchronization flashing based on GPS synchronization technology (optional). ● SMS fault alarm based on GSM communication technology (optional). ● Flame retardant level: UL94-V0.
---	--

General Specifications

Implementation standards	JT/T 761-2009	Marine lantern general technical conditions
	JT 7007-1993	Marine lantern intensity measurement and light range calculation
	GD22-2015	Electrical and electronic products type approval test guide

Electrical		Mechanical structure parameters	
Rated Voltage	AC100V~240V	Main material	Body:ABS+PC PC housing:PC
Maximum power	25W	IP rate	IP66/IP68
Lamp source	LED	Ambient Humidity	10%~95%RH (No condensation)
Input Current	0.6A @115VAC 0.34A @230VAC	Operating temperature	Ta-40°C ~ +60°C
Inrush Current	16A @115VAC 30A @230VAC	Weight	2.1 Kg
Frequency	50Hz~60Hz	Color	White

Optical parameters			
Light-emitting element	LED	Color	Red, green, blue, yellow, white
Working way	256 kinds of flash rate adjustable	Photocell illumination threshold	200-500LX(adjustable)
Vertical degree	≥7°	Horizontal degree	360°
Visual distance	5NM(77cd,Intensity gear 30%) 7NM(270cd,Intensity gear100%)		

Mounting dimensions

Unit mm

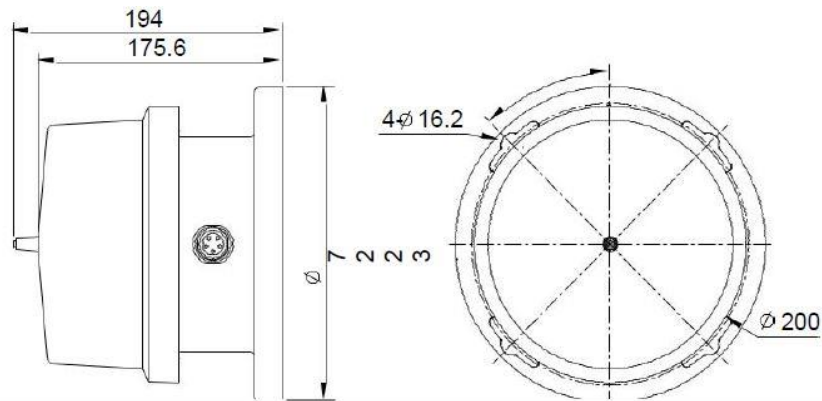

Installation instructions

1. Open the box, the package contains the following items:

No	Material name	Quantity(pcs)	Description
1	Marine lantern	1	Marine lantern
2	Five-core aviation plug	1	Used to connect the power and RS-485 communication interface.1
3	Infrared remote control	1	Align the digital tube remote control operation.2
4	Ziplock bag	1	Equipped with other spare parts.
5	English manual and warranty card	1	manual, warranty card.3

1. Can be customized to connect the first line head plugs, need to provide wire and line length.
2. Please refer to the infrared remote control instructions for use, and safekeeping.
3. Please keep for a long time.

2. Remove the five-core aviation plug, according to the site construction conditions from the distribution cable, it is recommended to use sheathed cable (5 core / 1.5mm²), and in accordance with the following figure to make aviation plug line: (Aviation plug can customized, need to provide wire and cable length info)

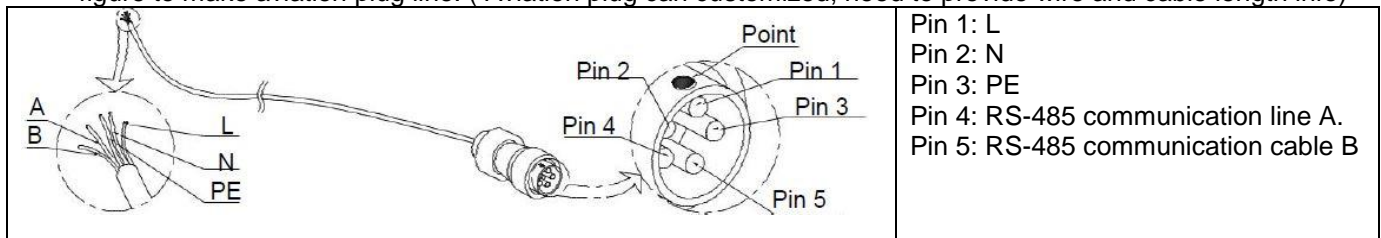

Attention: After the cable is connected, the rear nut of the five-core aviation plug must be tightened to ensure the waterproof requirements;

The five-core aviation plug in the pin can not be short-circuited;

Airline plug the other end of the mark to avoid confusion;

When the RS-485 communication interface is not needed, the pin 4 and the pin 5 may not be connected.

3. SIM card installation instructions (only with GSM products, card slots for SIMCARD card type, that is often said that the card)

- Use a Phillips screwdriver to open the bottom cover of the lamp
- SIM card into the SIM card slot, hear a click, indicating that the installation is complete; pay attention SIM card insertion direction;
- After confirmation, fasten the bottom cover with a Phillips screwdriver, and pay attention to the installation direction of the bottom cover (positioning bayonet at one end, as shown below).



4. Digital tube display instructions









- 1) Turn on the power, the lamp into the self-test state, the digital display shows the current self-test items.
- 2) When the digital display "atgd", self-test normal, then enter the sleep state.
- 3) When the LED display "ater", self-test anomalies, and then into hibernation.
- 4) If there is a self-test abnormality, please check whether the SIM card and SIM card are in normal use status.
- 5) Press any button on the remote to wake up the digital tube to enter the display state.
- 6) Display status, the digital tube alternately displays the current page and the corresponding page value.
- 7) Setting state, digital tube still display the current page value.
- 8) 1 minute without key operation remote control, nixie tube in hibernation (not shown).
- 9) Digital control of the page, the page value and meaning of the table below:

Page	Page Value	Meaning
Stat	On	Manually turn on the lights, light control does not work in this state, the lights always work.(Do not keep this mode for a long time.)
	Off	Turn off the light manually, light control does not work in this state, the light is always off.
	Auto	Automatic, light control works. (Factory set to auto)
Flash	0-255	IALA flash rate (ie, flashing mode), and light quality table corresponding.1 (factory setting is 248)
elnt	0p-100p	Light gear. (Set according to the visual range, the default 30p)
n2d	0-650l	Evening, the light control automatically turn on the light illumination value, in Lx. (Factory setting is 300l)
n2d	0-650l	At dawn, light control automatically turn off the light illumination value, in Lx. 2 (Factory setting is 400l)
batt (Non-setting items)	12.0 (for example)	The current DC power supply voltage 12.0V
gps (Non-setting items)	Srch	GPS is in the search star status
	good	GPS is normal.
lerr (Non-setting items)	Ok	Normal
	err	alarm

























1.The flashing mode can be downloaded from the official website or contact sales staff.













2. N2d setting value must be bigger than d2n.

5. Infrared remote control operating instructions

Picture for reference, please prevail in kind	Instructions
	<p>When first used, remove the insulation from the bottom of the remote control. Aim the remote control at the digital tube, press any key to wake up digital tube, enter the display state.</p> <p>Press  /  page , Left / right to switch the page, digital tube alternately displays the current page, page value.</p> <p>Switch to the desired settings page,  Enter the setting state, digital tube static display the current page value.</p> <p>Press  /  , Increase / decrease to set the current page value, you can also press the number keys to directly modify the current page value.</p> <p>To save the settings, press  Key to save and exit the setting status.</p> <p>If you do not need to save, press  Exit the setting status directly.</p> <p>No key within 1 minute, digital tube automatically go to sleep.</p> <p>If you do not use the remote control for a long time, please insert the insulation sheet back into place.</p>

6. Infrared remote control operating examples





<p>stat(light mode)setting example: Set auto mode</p> <ol style="list-style-type: none"> 1.If LED display is in sleeping status, press any key to awake LED display and enter into display status. 2.Press  /  page down/up to stat page. And then press enter  into setting status. LED display indicate current light mode statically. 3.Press  /  to switchover among on/off/auto. Find demanded page: auto. 4.Press  save and quit setting status.
<p>flsh (light character) setting example: Set flashing 123</p> <ol style="list-style-type: none"> 1.If LED display is in sleeping status, press any key to awake LED display and enter into display status 2.Press  /  page down/up to FLSH page. And then press enter  into setting status. LED display indicate current light character statically. 3.Press  /  plus/minus. Adjust to value 123. Or press digital key 1,2,3 in turn. LED display indicates 123. 4.Press  save and quit setting status.
<p>elnt (Intensity) setting instruction example: Set intensity 30p</p> <ol style="list-style-type: none"> 1.If LED display is in sleeping status, press any key to awake LED display and enter into display status 2.Press  /  page down/up to elnt page. And then press  enter into setting status. Led display indicate current light intensity statically. 3.Press  /  plus/minus. Adjust to value 30p. Or press digital key 3,0 in turn. LED display indicate 30p. 4.Press  save and quit setting status.
<p>d2n(Indicates the ambient brightness (in lx) at which the lantern LEDs will turn on in the evening.)setting example: Set 300L</p> <ol style="list-style-type: none"> 1.If LED display is in sleeping status, press any key to awake LED display and enter into display status 2.Press  /  page down/up to d2n page. And then press  enter into setting status. LED display will indicate illuminance value. 3.Press  /  plus/minus. Adjust to value 300L. Or press digital key 3,0,0 in turn. LED display indicate 300L. 4.Press  save and quit setting status.



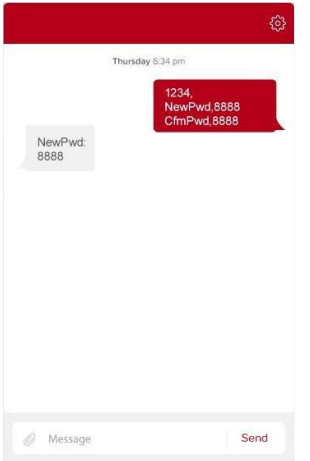
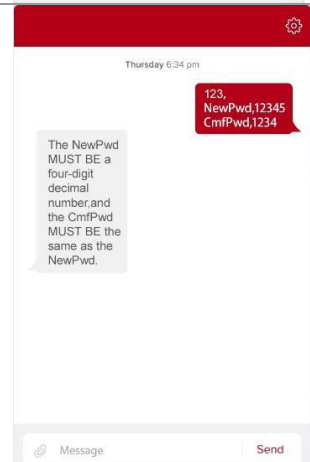

<p>n2d(Indicates the ambient brightness(in lx)at which the lantern LEDS will turn off in the morning.)setting example: Set 400L</p> <p>1.If LED display is in sleeping status, press any key to awake LED display and enter into display status</p> <p>2.Press  /  page down/up to n2d page. And then  press enter into setting status. LED display will indicate illuminance value.</p> <p>3.Press  /  plus/minus. Adjust to value 400L. Or pres digital key 4,0,0 in turn. LED display indicate 400L.</p> <p>4.Press  save and quit setting status.</p>
<p>batt(battery voltage)checking</p> <p>1.If LED display is in sleeping status, press any key to awake LED display and enter into display status</p> <p>2.Press  /  page down/up to batt page. LED display will indicate batt and current voltage value alternately.</p>
<p>gps (GPS signal status)</p> <p>1.If LED display is in sleeping status, press any key to awake LED display and enter into display status</p> <p>2.Press  /  page down/up to gps page. LED display will indicate gps and GPS signal status: Srch(searching) or good(singla is good).</p>
<p>lerr (alarm status)</p> <p>1.If LED display is in sleeping status, press any key to awake LED display and enter into display status</p> <p>2.Press  /  page down/up to lerr page. LED display will indicate alarml status: ok(normal) or err(fault).</p>

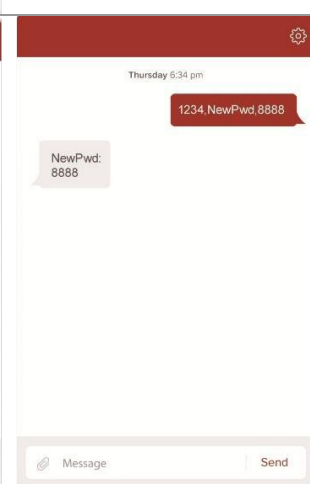
7.Other functions

<ul style="list-style-type: none"> ● RS-485 ● fault alarm ● Photocell ● GSM function (optional) ● GPS synchronization (optional) 	<p>Aviation plug with RS-485 communication interface, see the wiring instructions. Through the digital control, RS-485, GSM prompt fault. (Need to select the corresponding function)</p> <p>According to the value of environmental illumination, the lights turn on and off automatically. (Need stat page value is auto)</p> <p>Send a "NANHUA" message to the SIM card number to receive a message. (See GSM operation instructions)</p> <p>Light with the same flash rate, flashing simultaneously.</p>
---	--

GSM operation instruction	
<p>Picture for reference, please prevail in kind</p> <p>No picture</p> 	<p>Instructions</p> <p>Preparation before operation Turn on the switch self test normal. Phone input method set to English.</p> <p>Receive operating instructions Send SMS "NANHUA" and get a reply message with instructions.</p>

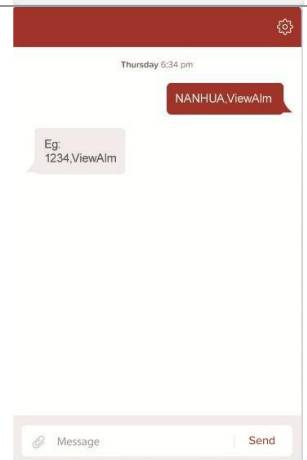
		<p>Set a new password</p> <ol style="list-style-type: none"> 1. Send SMS "NANHUA, NewPwd" to the light to get message prompt, as shown in the left picture 1. 2. You can also send text messages "old password, NewPwd, new password, CfmPwd, confirm the new password", as shown in the left picture 2.
		<p>Set new password failed prompt</p> <p>If the new password format does not meet the requirements or enter a new password twice inconsistent will receive a prompt message, as shown in the left.</p>
		<p>Set the alarm to receive the phone number</p> <ol style="list-style-type: none"> 1. Send SMS "NANHUA, AlmPhn" to the luminaire, get message prompt, as shown in the left picture 1. 2. Can also directly send text messages "password, AlmPhn, cell phone number", as shown in the left picture 2.
		<p>Read the parameters</p> <ol style="list-style-type: none"> 1. Send SMS "NANHUA, ViewPara" to the light, get message prompt, as shown in the left picture 1. 2. Can also send text messages directly "password, ViewPara", as shown in the left picture 2.

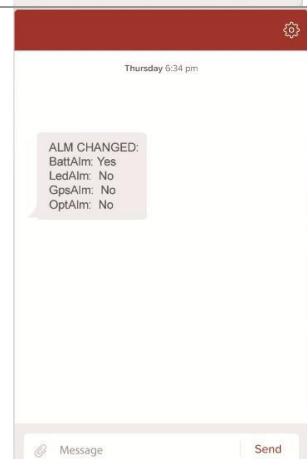
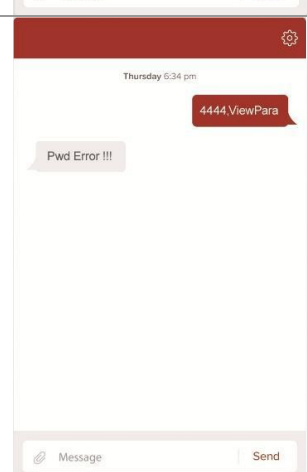
		<p>Setting parameters</p> <ol style="list-style-type: none"> 1. Send a message "NANHUA, SetPara" to the light, get message prompt, as shown in the left picture 1. 2. Can also send text messages directly "password, SetPara: Stat:On Flsh:2 Elnt:50 D2n:400 N2d:500", as shown in the left picture 2. <p>Noted: Only need to input the parameters must be changed. For example, the light intensity can be modified as follows: „Password, settPara: Eint:50”</p>
		<p>Read the fault alarm status</p> <ol style="list-style-type: none"> 1. Send SMS "NANHUA, ViewAlm" to the light, get message prompt, as shown in the left picture 1. 2. Can also send text messages directly "password, ViewAlm", as shown in the left picture 2.
		<p>Alarm status change, receive active reminder SMS</p> <p>Need to set the alarm to receive mobile phone number in advance.</p>
		<p>Password error message</p> <p>Please enter the correct password to continue.</p>

Precautions

- Products using PC material components (such as PC housing), can not be with industrial alcohol, banana water, isopropyl alcohol, carbon tetrachloride, cyclohexanone and other organic solvents directly or indirectly contact, otherwise it will be corrosion cracking.
- This product light control detected ambient illumination changes, the switch state will have a few seconds delay.
- There will be a few seconds of light fault alarm alarm, is a normal phenomenon.
- Light control fault alarm has a 24-hour delay, is a normal phenomenon.
- GPS fault alarm 1 hour delay, is a normal phenomenon.
- Before disconnecting the power supply, do not open any part of the lamp body to prevent any danger.
- Do not look directly at the light out of the light, so as not to damage the eyes.

Order number

Product code	Input voltage	Color	RS-485 connect	GSM function	GPS Synchronize	Photocell
1000358-001	AC100-240V	Red	Yes	Yes	Yes	Yes
1000358-002	AC100-240V	Red	Yes	No	Yes	Yes
1000358-003	AC100-240V	Yellow	Yes	Yes	Yes	Yes
1000358-004	AC100-240V	Yellow	Yes	No	Yes	Yes

Thank you for using our products. As a professional brand of signal transmission and high quality industrial lighting,

Please be sure to read and understand the instructions based on the correct use of this product. Incorrect installation and use may cause fire, electric shock and other hazards. Due to product improvements, specifications and styling changes may change without notice, please understand.